

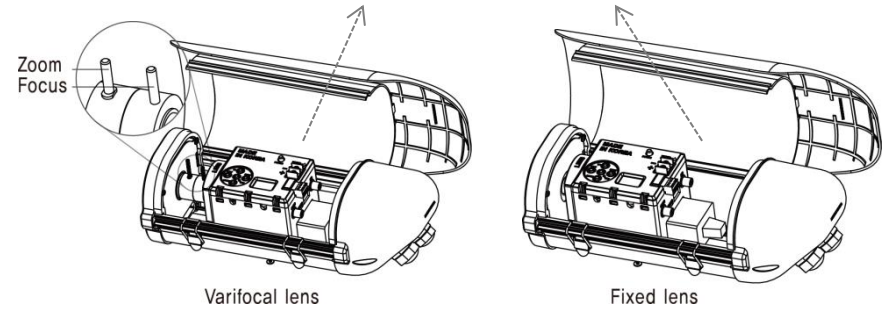

EX-SDI + 4MP

Easy Ceiling Wall indoor IR 12

Resolution	1440P, 1080P, 720P
Lens	Fixed lens 3.6mm, 4mm, 6mm / V/F Lens 2.8~8mm, 2.8~12mm, 3.5~16mm
Sensor	1/2.8 inch SONY CMOS (IMX-335)
Pixels	Total : 2704(H) x 2104(V) = 5.69M / Effective : 2616(H) X 1964(V) = 5.14M
Scanning System	PROGRESSIVE
S/N (Y signal)	More than 52 dB (AGC Off)
Video Output	SMPTE274M (EX-SDI, HD-SDI) / (TVI, AHD, CVI, CVBS: 1.0Vp-p (75ohm) : Option)
Min.Illumination	0 Lux at IR On (IR LED 12)
White Balance	Auto / Auto Ext / Preset / Manual
Electronic shutter speed	AUTO / MANUAL (1/30sec ~ 1/30,000sec) / FLICKER
Function	DNR / ACE / WDR / BLC / HLC / Sens_up / Privacy / Flip / Motion / Defog / RS-485 / Sharpness / Smart IR / Brightness
Day & Night	AUTO (Day <-> Night TIME Change) , COLOR , B/W, EXTERN
Language	ENG, CHN, CHN(S), JPN, KOR
Temperature/Humidity	Operating (-10°C~+50°C / 30%~80% RH) / Storage (-20°C~+60°C / 20%~90% RH)
Power	DC12V [AC24V / DC12V DualPower (option)]
signal Transmission	The distant difference is occurred according to cable option and other circumstances. (based on 5C-HFBT : HD-SDI (100M) / EX-SDI (500M))

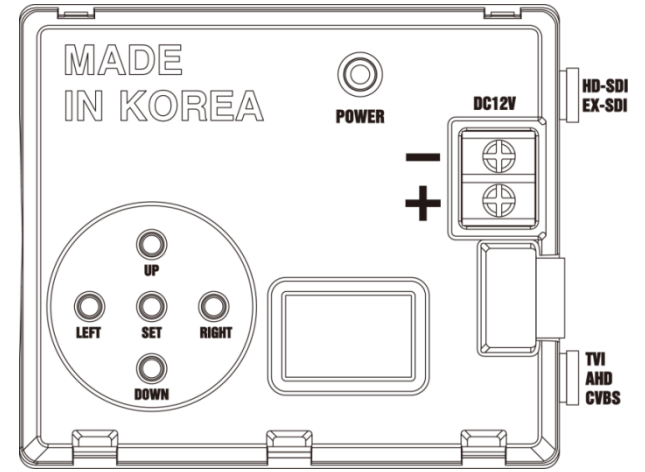

[Installation Features]

1. Control FUNCTION directly through UCC communicate of DVR and OSD KEY as well.
2. Select output image
 - EX-SDI : Right (R), Right (R), Set
 - TVI : Up (U), Up (U), Set
 - AHD : Down (D), Down (D), Set

[Recommended Distance]

1. Installation height of camera should be within 3M ~ 8M.
 - 6 ~ 50mm Lens: Shooting distance within 20M ~ 30M
 - 7 ~ 22mm Lens: Shooting distance within 15M ~ 25M
 - 16mm Lens: Shooting distance within 10M ~ 20M

